

SQN9..., front
(covers removed)

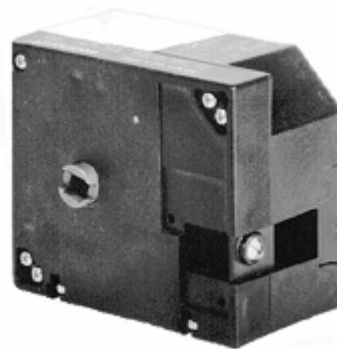

SQN9..., rear
(covers fitted)

Damper Actuators

SQN9...

Reversible electromotoric actuators for air dampers and valves of oil or gas burners of small to medium capacity.

The SQN9... and this Data Sheet are intended for use by OEMs which integrate the damper actuators in their products!

Use and features

The SQN9... actuators are designed for driving gas or air dampers of oil or gas burners of small to medium capacity, for load-dependent control of the fuel and combustion air volume:

- In connection with P-PI or PID controllers, such as the RWF40...
- Directly via the different types of burner controls, such as LOA..., LMO..., LMG..., LFL...
- In connection with 1- or 2-wire control or 3-position controllers

- Holding torque: 0.8...2.4 Nm
- Running time: 4...24 s
- Direction of rotation:

SQN90...	counterclockwise
SQN91...	clockwise
- SQN9...
 - Fixing holes and cable entries
 - Equivalent to actuators of the same category made by Conectron and Berger

Warning notes



To avoid injury to persons, damage to property or the environment, the following warning notes should be observed!

Do not open, interfere with or modify the actuators!

- All activities (mounting, installation and service work, etc.) must be performed by qualified staff
- Before making wiring changes in the connection area of the actuator, completely isolate the equipment from the mains supply (all-polar disconnection)
- Ensure protection against electric shock hazard by providing adequate protection for the connection terminals and by securing the cover
- Each time work has been carried out (mounting, installation, service work, etc.), check to ensure that wiring is in an orderly state and that parameters are correctly set
- Fall or shock can adversely affect the safety functions. Such actuators must not be put into operation even if they do not exhibit any damage

Mounting notes

- Ensure that the relevant national safety regulations are complied with

Standards and certificates



Conformity to EEC directives
- Electromagnetic compatibility EMC (immunity)
- Low-voltage directive

89 / 336 / EEC
73 / 23 / EEC



ISO 9001: 2000
Cert. 00739



ISO 14001: 2004
Cert. 38233



Only valid for
SQN70.xxxRxx
SQN71.xxxRxx

Disposal notes



The actuator contains electrical and electronic components and must not be disposed of together with household waste.

Local and currently valid legislation must be observed.

Mechanical design

Housing	<ul style="list-style-type: none">- Made of impact-proof and heat-resistant plastic- The housing accommodates:<ul style="list-style-type: none">– The reversible synchronous motor with the gear train, which can be disengaged– The camshaft of the control section– The relays, depending on the type of actuator– The switches, connected to the terminals via the printed circuit board- Color: black
Drive motor	<ul style="list-style-type: none">- Reversible and locking-proof synchronous motor
Coupling	<ul style="list-style-type: none">- Drive shaft can be manually disengaged from the gear train and motor (by pressing screw «K»)- Automatic reengagement
Adjustment of switching points	<ul style="list-style-type: none">- By means of adjustable cams- Scales beside the cams indicate the angle of the switching points- Cams can be adjusted manually or with the enclosed hook-spanner or a similar tool
Position indication	<ul style="list-style-type: none">- Via scale at the end of the camshaft and index on the front
Electrical connections	<ul style="list-style-type: none">- Refer to «Technical data»
Geartrain	<ul style="list-style-type: none">- Maintenance-free
Drive shaft	<ul style="list-style-type: none">- Made of sinter metal- Ready fitted to the front of the gear train
Mounting and fixing	<ul style="list-style-type: none">- Rear of the gear train is used as the mounting surface- Actuator is secured via through-holes- Housing side with recessed fixing nuts M4

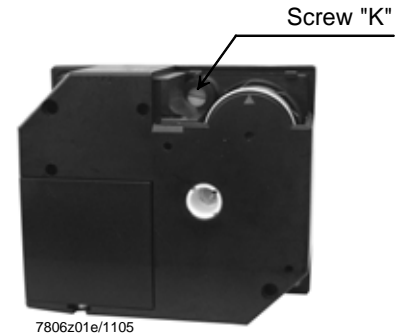

Type summary (other types of actuators available on request)

Actuators SQN90... / counterclockwise rotation ¹⁾

Diagram no.	Function sequence no.	Running time at 50 Hz ²⁾ for 90° s	Nominal / starting torque Nm	Mains voltage / mains frequency	
				AC 230 V ⁴⁾ +10 % / -15 % 50...60 Hz	AC 115 V ³⁾ +10 % / -15 % 50...60 Hz
S3	F2, F3	12	2.4	SQN90.204A2799	---
S2	F2, F3	12	2.4	SQN90.220A2799	---
S4	F1	12	2.4	SQN90.240B2799	---
S5	F4	10	2	SQN90.350A2799	---

Actuators SQN91... / clockwise rotation ¹⁾

Diagram no.	Function sequence no.	Running time at 50 Hz ²⁾ for 90° s	Nominal / starting torque Nm	Mains voltage / mains frequency	
				AC 230 V ⁴⁾ +10 % / -15 % 50...60 Hz	AC 115 V ³⁾ +10 % / -15 % 50...60 Hz
S4	F1	4	0.8	SQN91.140B2799	SQN91.140B1799
S2	F2, F3	12	0.8	SQN91.220A2799	---

Other types of actuators are available on request.

Legend

- 1) At 60 Hz, running times are about 20 % shorter
- 2) AC 115 V +10 % / -15 % possible, but in the case of undervoltage, torque is reduced by about 20 %
- 3) AC 230 V +10 % / -15 % possible, but in the case of undervoltage, torque is reduced by about 20 %
- 4) When facing the drive shaft and when control voltage is supplied to end switch I

Ordering

When ordering, please give type reference according to «Type summary».

Technical data

General actuator data

Actuator	Mains voltage	AC 220 V –15 %...AC 240 V +10 % AC 100 V –15 %...AC 110 V +10 %
	Mains frequency	50...60 Hz ±6 %
	Primary fuse (external)	6.3 AT (to be supplied by thirds)
	Drive motor	synchronous motor
	Power consumption	8 VA
	Angular adjustment	max. 90°, scale range 0...90°
	Mounting position	optional
	Safety class	II to VDE 0631
	Cable connections	screw terminals for min. 0.5 mm ² and max. 2.5 mm ² cross-sectional area
	Ferrules	matching the dia. of the stranded wire
	Direction of rotation	refer to «Type summary»
	Nominal torque	refer to «Type summary»
	Running time	refer to «Type summary»
	Weight (average)	approx. 550 g

End and auxiliary switches

Number of end switches	2	
Number of auxiliary switches	max. 3	
Actuation	via camshaft	
Breaking voltage	AC 24...250 V	
Adjustment of cams	infinitely	
Perm. load on terminals at cos φ = 0.9:	Peak current	Operating current
Switching		
- Under load «On», without load «Off»	max. 14 A	2 A
- Under load «On», under load «Off»	max. 7 A	1 A

Environmental conditions

Storage	DIN EN 60 721-3-1
Climatic conditions	class 1K3
Mechanical conditions	class 1M2
Temperature range	-20...+60 °C
Humidity	< 95 % r.h.
Transport	DIN EN 60 721-3-2
Climatic conditions	class 2K2
Mechanical conditions	class 2M2
Temperature range	-50...+60 °C
Humidity	< 95 % r.h.
Operation	DIN EN 60 721-3-3
Climatic conditions	class 3K5
Mechanical conditions	class 3M2
Temperature range	-20...+60 °C
Humidity	< 95 % r.h.



Condensation, formation of ice and ingress of water are not permitted!

Function

A synchronous motor drives the drive shaft and the camshaft via a gear train. The camshaft actuates the end and auxiliary switches. Using the associated cam, the switching position of each end and auxiliary switch can be adjusted within the working range. Some of the actuator versions are equipped with electronic modules, which perform auxiliary functions in connection with the end and auxiliary switches, or with external devices, such as controllers.

Camshaft

The camshaft has 2 pointers for indicating the direction of rotation.

The pointers are assigned as follows:

- Double pointer → SQN90...
- Single pointer → SQN91...



Internal diagrams



The following connection diagrams show the start position as supplied:

- End switch position II «Closed»
- Dead

Diagram S1

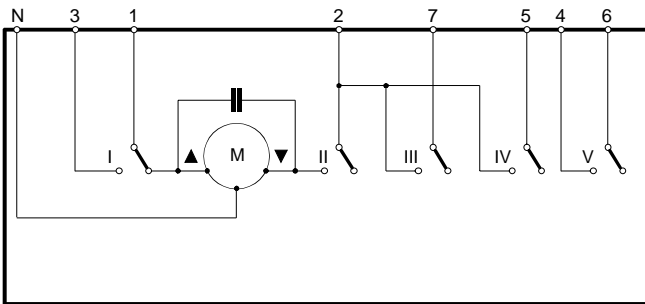

780604/0795

Diagram S2

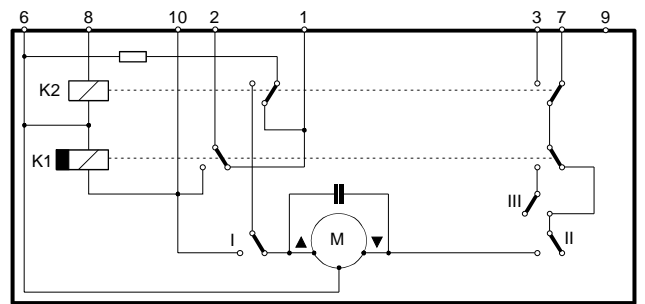

780602/0695

Diagram S3

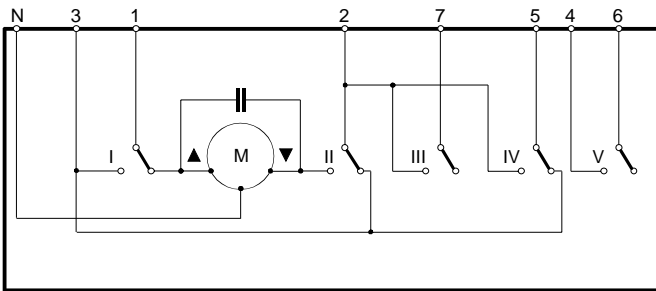

780605/0795

Diagram S4

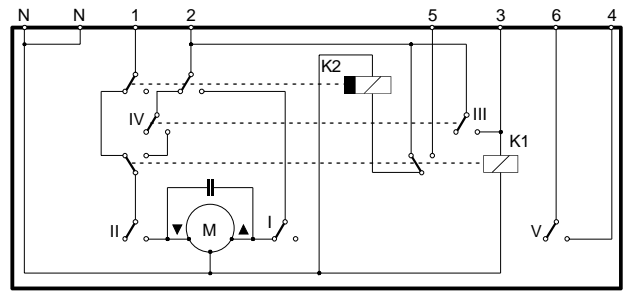

780601/0795

Diagram S5

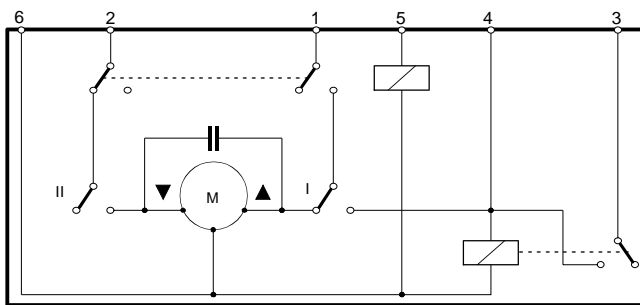

780603/0795

Function sequence

Function sequence F1

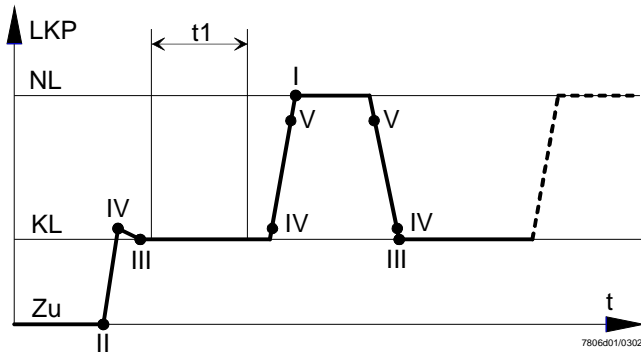

Function sequence F2

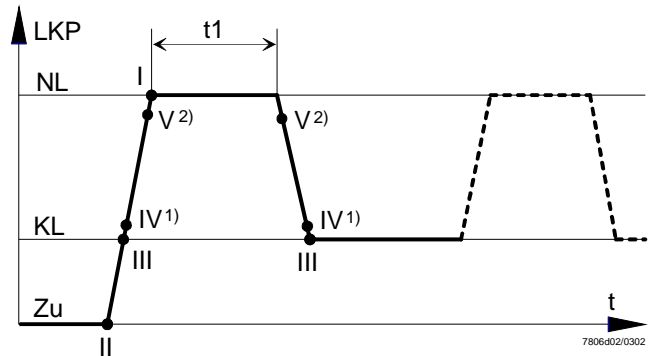

Function sequence F3

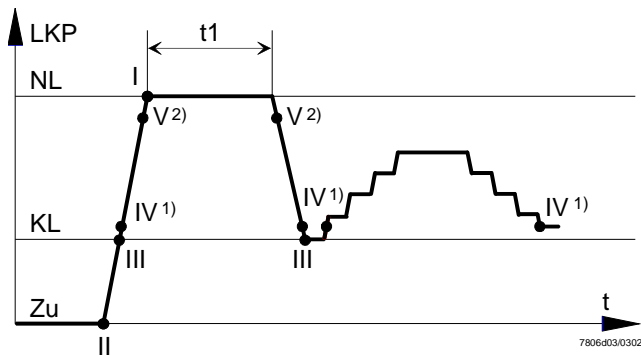

Function sequence F4

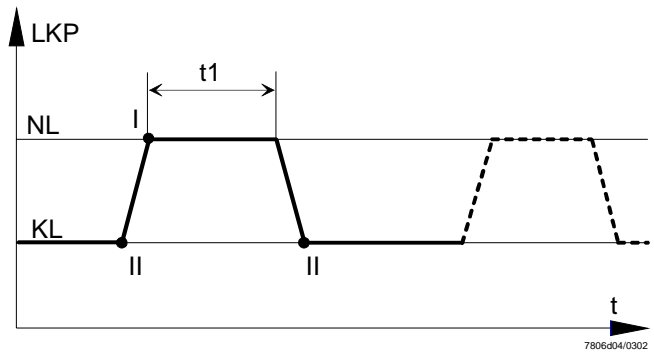

Legend

- KL Low-fire
- LKP Air damper position
- NL Nominal load
- t Time
- t_1 Burner control's prepurge time
- I...V Cam switches or auxiliary switches
- 1) Cam switch positions do not apply to internal diagram S2
- 2) Cam switch positions do not apply to internal diagram S2 and S7

Dimensions

Dimensions in mm

Drawing shows actuator with terminal cover removed

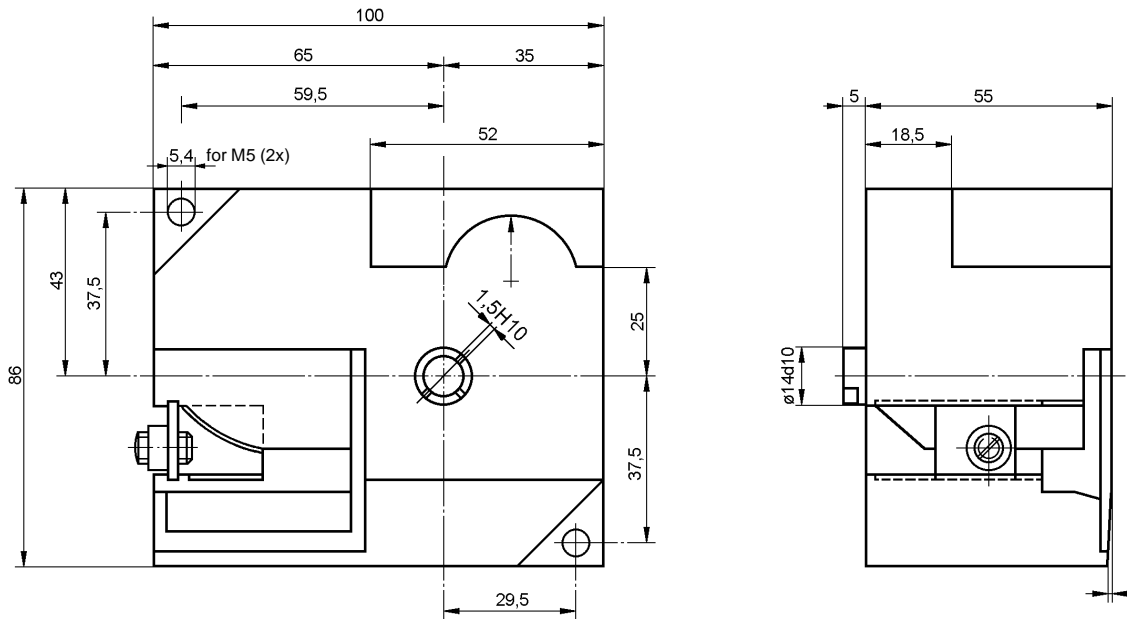

Schematic drawing

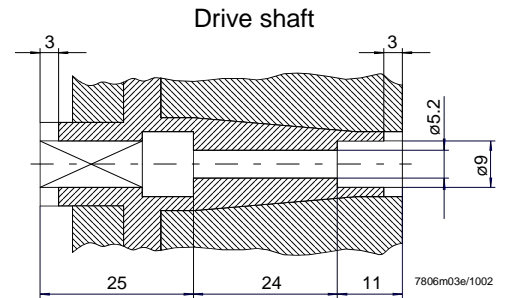
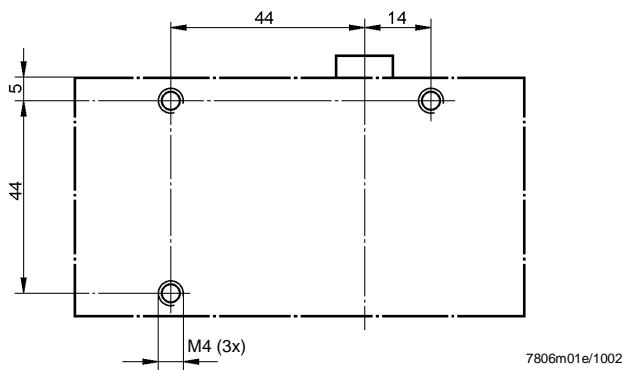

SQN90...

SQN91...

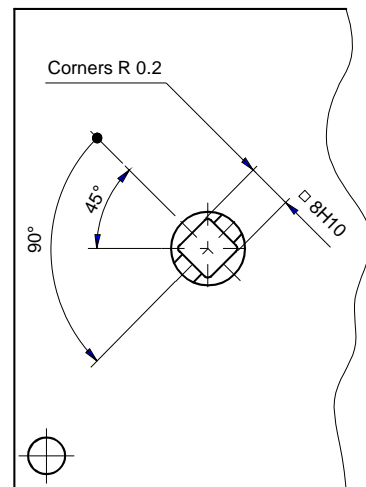
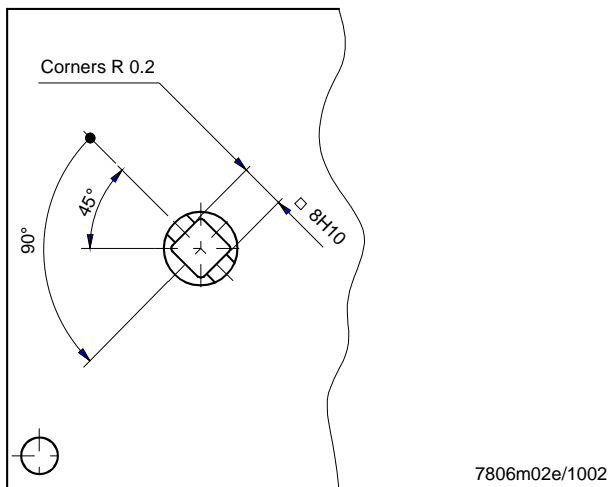

Drive shafts shown in «fully closed» position (end switch II)